

PRODUCT INFO

TRUNK-BAG

Waterproof trunkbag for E-Bikes and other bikes

TOP LOCK



PVC free



PFAS free

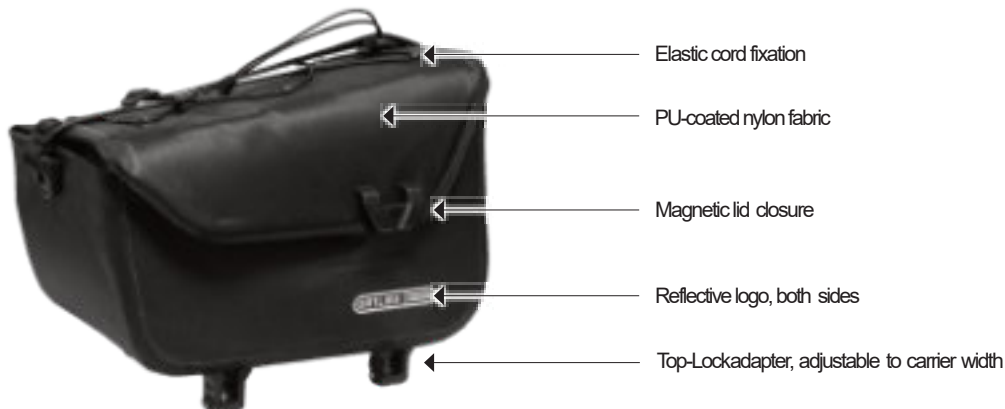

Elastic cord fixation

PU-coated nylon fabric

Magnetic lid closure

Reflective logo, both sides

Top-Lockadapter, adjustable to carrier width

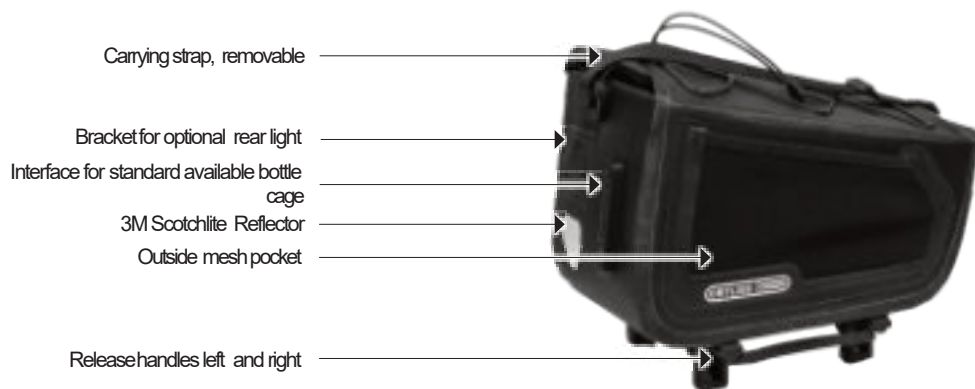

Carrying strap, removable

Bracket for optional rear light

Interface for standard available bottle cage

3M Scotchlite Reflector

Outside mesh pocket

Releasehandles left and right



Option: Rearlight, bottle cage with water bottle (all optional, not included)

height cm/in.	width cm/in.	depth cm/in.	vol. L/cu.in.	weight g/oz.	max. load kg/lbs.
17/20 / 6,7/7,9	32/12,6	18/7,1	10/610	980/34.6	10/22

SPECIFICATIONS:

- + Waterproof trunkbag for E-bikes and other bikes
- + Magnetic lid closure
- + Preparation for mounting standard bottle cages (bottle cage not included)
- + Elastic cord fixation on upper side
- + Twoside pockets for valuables, one inside pocket for e-bike display
- + Flexible outside mesh pocket
- + Removable carrying strap
- + Mounting option for tail light (tail light not included)
- + With ORTLIEB Top-Lockadapter system, universal fastening system for bicycle racks
- + Quick to install and easy to remove
- + Bag can be removed completely and without residue
- + Compatible with almost all racks from 80 to 160 mm width
- + Suitable for rack diameter of 8-16 mm
- + Two convenient release handles left and right
- + Anti-slip device prevents movement on the luggage carrier
- + Audible „click“ sound when the hooks engage
- + Compatible with spring flap on bike carrier and E-bike racks (battery)
- + Hooks also work as parking feet

Contents: Trunk-Bag with universal Top-Lockadapter system

Attention: Maximum load 10 kg/22 lbs.!

Note: A second rack level allows QL2.1/QL3.1 bags to be attached at the same time

Note: For reaching protection standard IP53 (5=dust protected, 3=protected against splash water coming 60° to the vertical) the lid of the bag must be closed completely. Once submerged, the bag is not waterproof



PRODUCT INFO

TOP-LOCK
 Universal adapter system for mounting bags and baskets on the bicycle racks

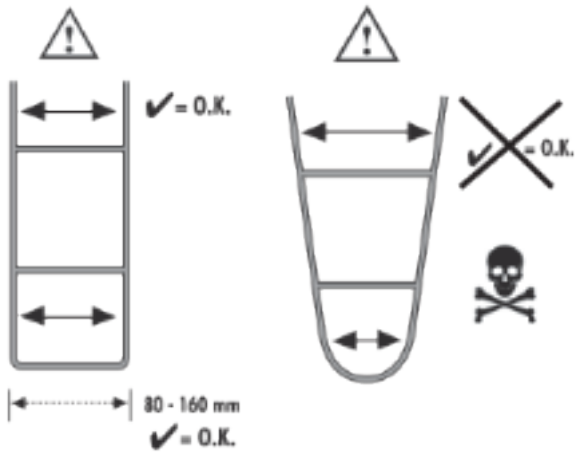
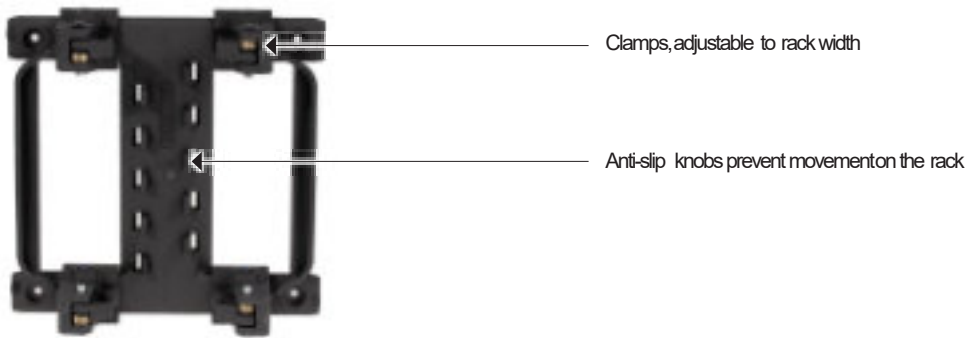

Top-Lock adapter must only be used on carriers with rectangular base, e.g. left and right rails must be parallel to each other



E-TRUNK



- DE MONTAGEANWEISUNG
- GB ASSEMBLY INSTRUCTIONS
- FR INSTRUCTIONS DE MONTAGE
- IT ISTRUZIONI DI MONTAGGIO
- NL MONTAGE HANDLEIDING
- DK MONTERINGSVEJLEDNING
- ES INSTRUCCIONES DE MONTAJE
- SE MONTERINGSANVISNING
- NO MONTERINGSANVISNING
- FI ASENNUSOHJEET
- PL INSTRUKCJA MONTAŻU
- JP 装着方法



INHALT:
CONTENTS:
CONTENU:
CONTENUTO:
INHOUD:
INDHOLD:
CONTENIDO:
INNEHÅLL:
INNHOOLD:
SISÄLLYS:
ZAWARTOSC:
内容物:



1x (A)

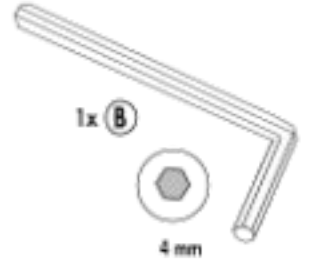

1x (B)

4 mm



1x (C)

1

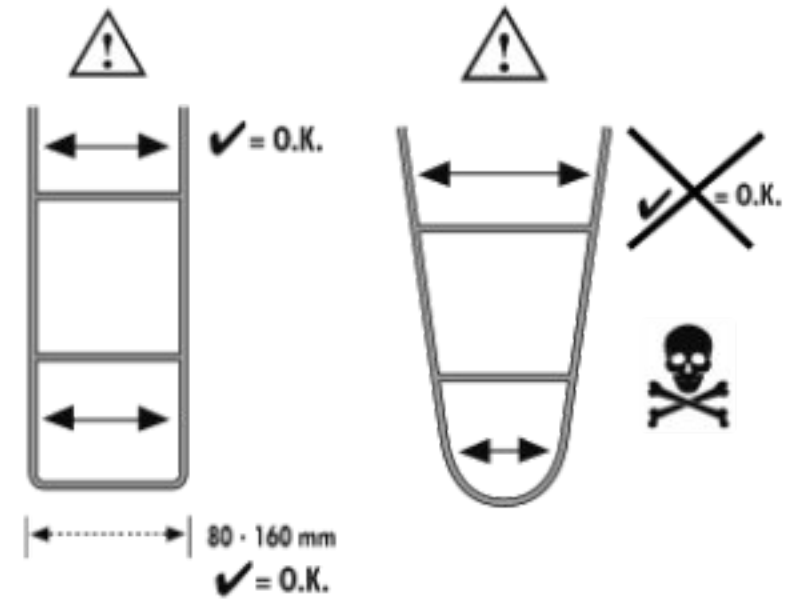
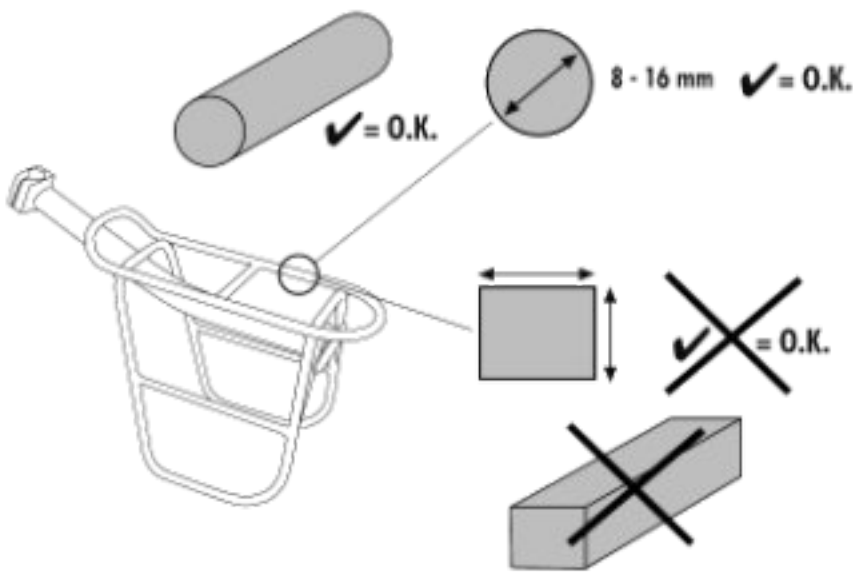

2

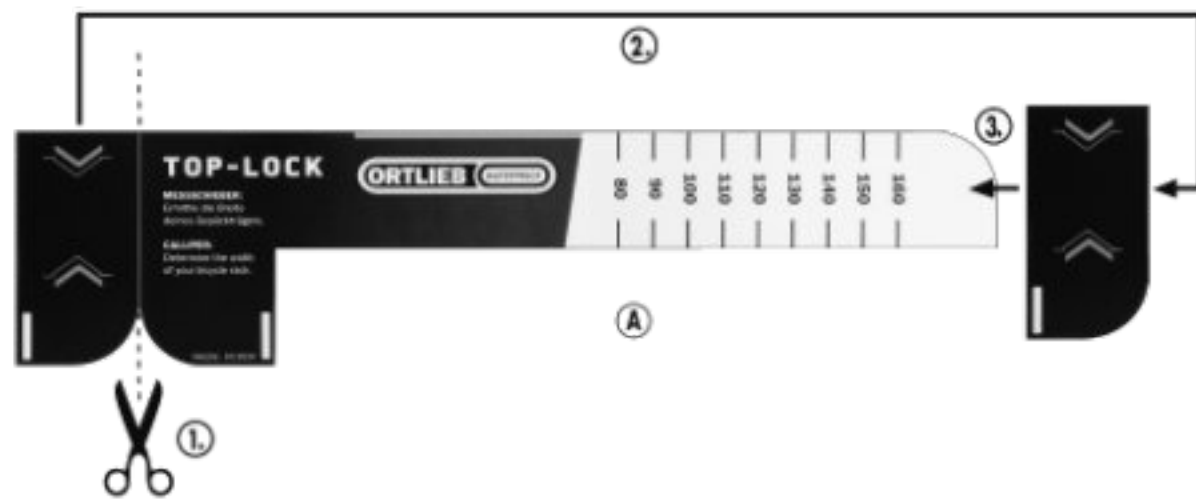

3

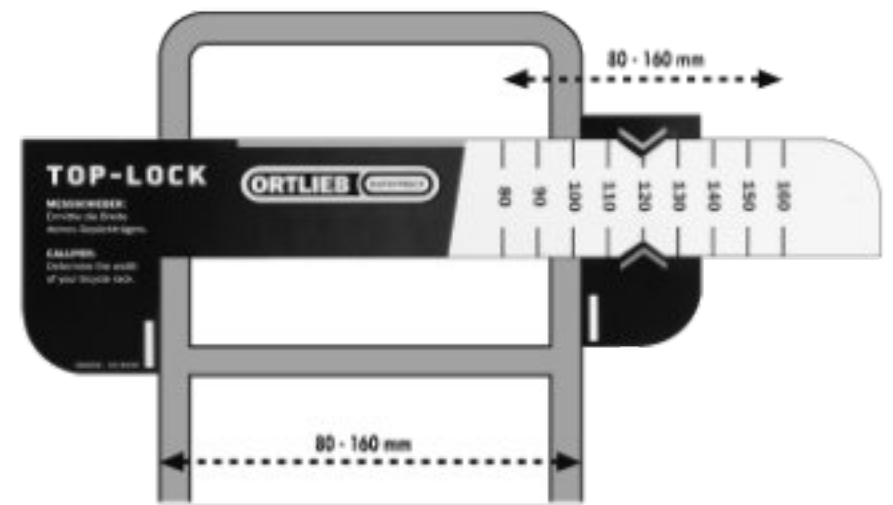

4 OPEN

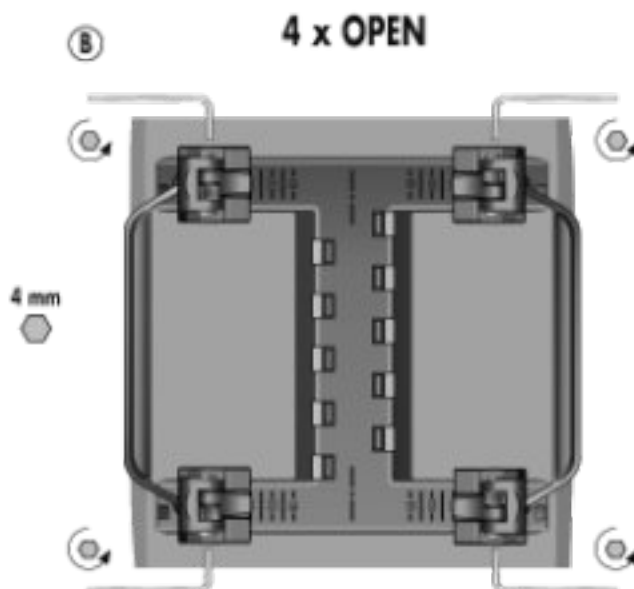

5 ADJUST

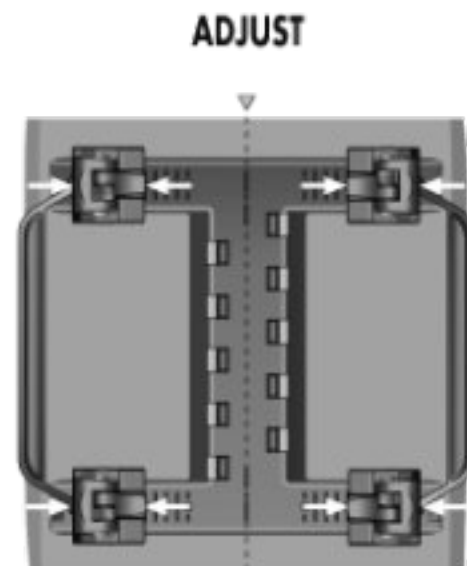

5 a. EXAMPLE

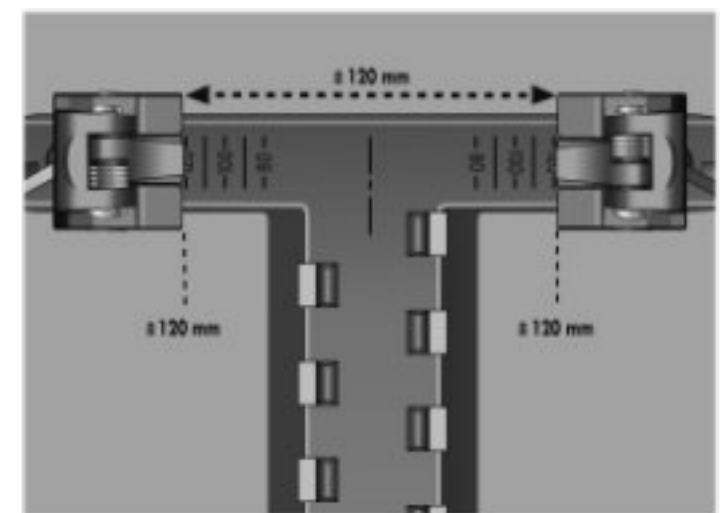

5 a.a. CLOSE

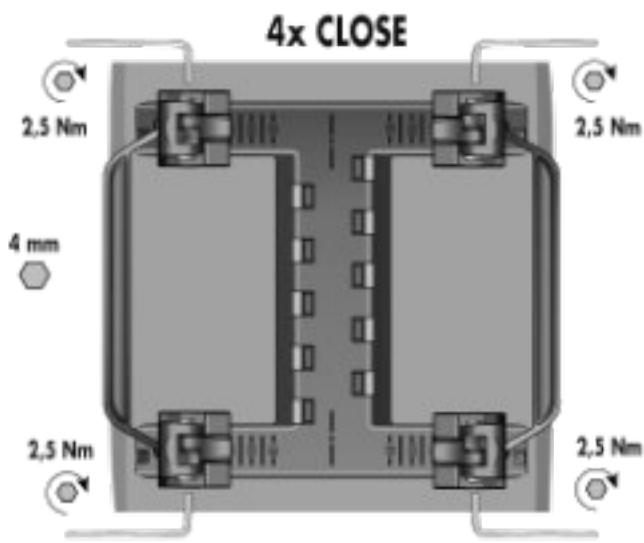

5 b.a. CORRECT POSITION



5 b.b. WRONG POSITION



5 c. FIX

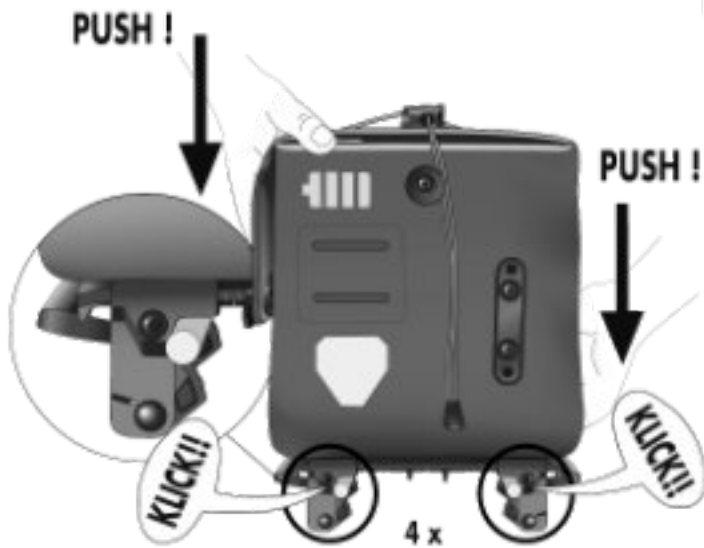

6 TEST

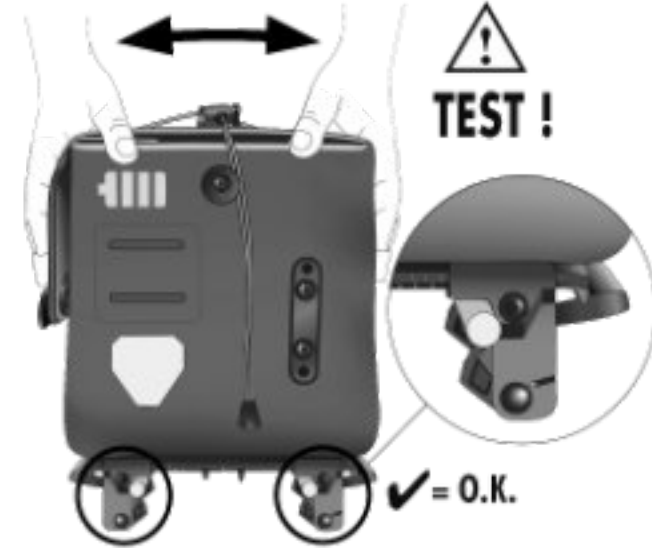

7 DIRECTION



8 UNFIX



9



10

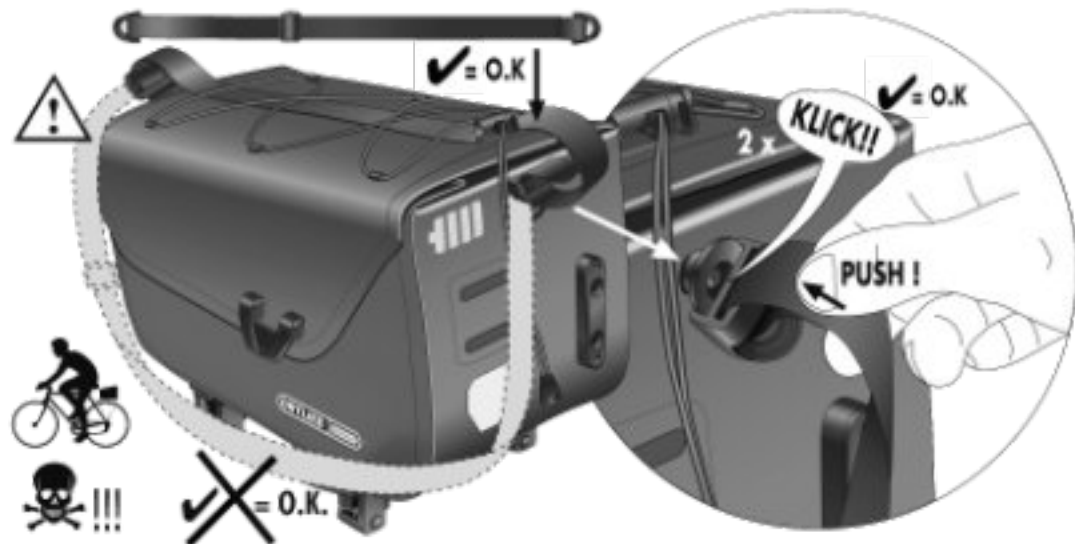

11



CHECK FIXATION BEFORE EVERY RIDE

- 1.) 10 km (6 Miles)
2.) 50 km (30 Miles)
3.) 100 km (60 Miles)
4.) 200 km (120 Miles)
..... etc.

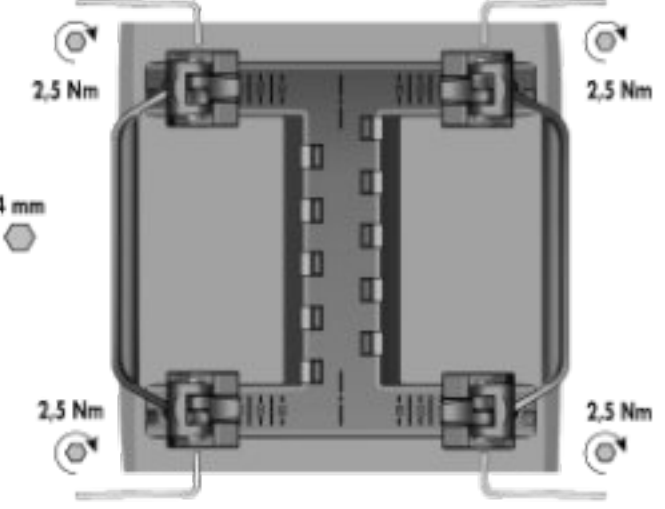

12 OPTION 1 BOTTLE/CAGE - not included



13 OPTION 2 LIGHT - not included



MAX. LOAD (INCL. BOTTLE)

